

INDOOR

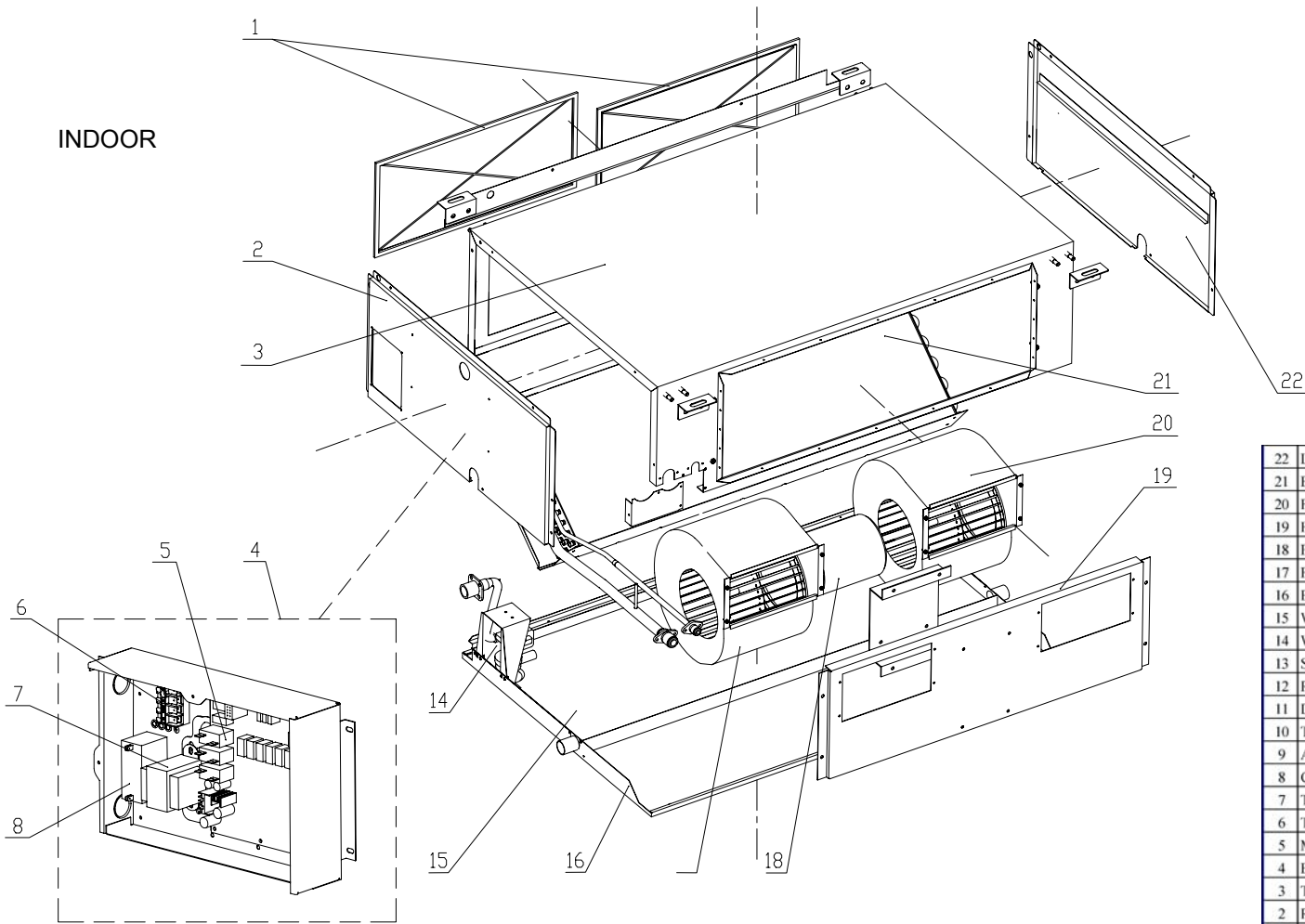

22	Left Side Plate Assy
21	Evaporator Assy
20	Fan Assy (Left)
19	Fan Fixed Plate Assy
18	Fan Motor
17	Fan Assy (Right)
16	Bottom Cover Assy
15	Water Tray Assy
14	Water Pump Assy
13	Signal Wire
12	Remote controller
11	Display Board
10	Tube sensor
9	Ambient Temperature Sensor
8	Capacitor
7	Transformer
6	Terminal Board
5	Main Board
4	Electric Box Assy
3	Top Cover Assy
2	Right Side Plate Assy
1	Filter Sub-Assy

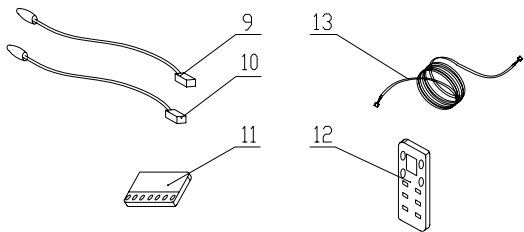

GFH48K3AI

OUTDOOR

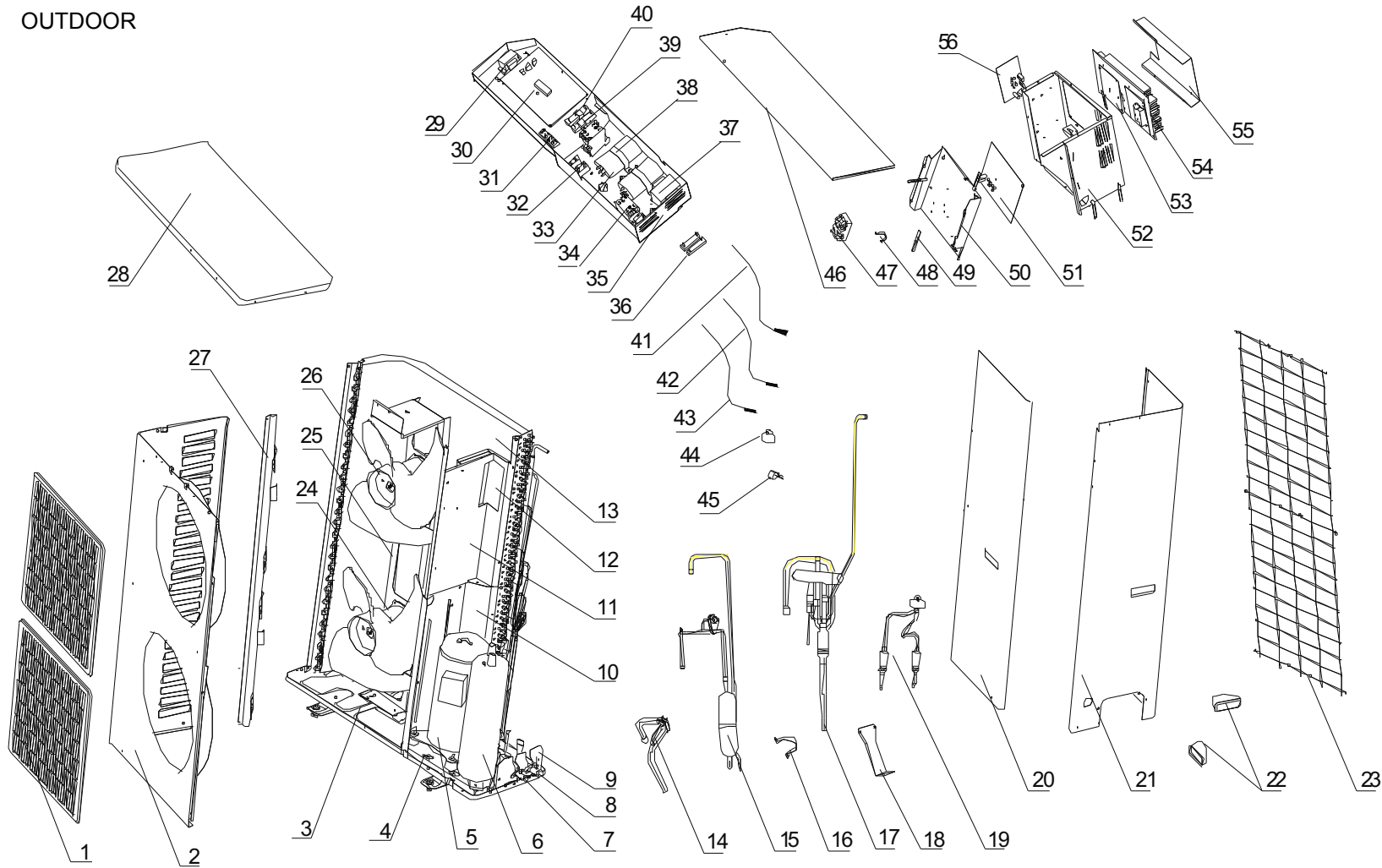

GUHD48NK3AO

GUHD48NK3AO

NO	Product Code	QTY	code
1	Front Grill	2	22414102
2	Front Plate	1	1435436
3	Metal Base	1	01195205P
4	Compressor Support Assay	1	01845203P
5	Compressor ANB42FBEMT	1	205210
6	Liquid-gas Separator	1	7425200
7	Gas Valve	1	7130212
8	Liquid Valve	1	7130210
9	Valve Support Assy	1	1715001
10	Isolation Plate2	1	1245205
11	Isolation Plate1	1	1245204
12	Block Plate	1	1245206
13	Condenser Assy	1	1125210
14	Suction Assay	1	4675215
15	Clamp	1	214000521
16	Discharge Assay	1	4635216
17	4-way Valve Assay	1	4145207
18	Fix Plate	1	01845209P
19	Electronic Expansile Valve Assy	1	7335204
20	Front Side Plate Assy	1	1305430
21	Back Side Plate	1	1305434
22	Handle	3	26235253
23	Protection Grill	1	1475432
24	Motor LW92C	2	150154511
25	Motor Support	1	1804113
26	Axial Flow Fan	2	10338731
27	Condenser Bracket	1	1895202
28	Top Cover	1	1255262
29	Transformer SC33A	1	43110177
30	Main PCB1 WZ4D35	1	30224036
31	Terminal Board	1	42011103
32	Capacitor CBB61 4uF/500V	2	33010013
33	Capacitor 4700uF/450V	1	33310524
34	AC Contactor	1	44010254
35	Electric Box Assay1	1	1395354
36	Cement Resistance 33K Ω /10W	0	
37	Inductance 275uH+275uH/40A	1	43120021
38	Cement Resistance 47 Ω /40W	1	34050010
39	Clamp	1	2144701
40	Clamp	1	214000512
41	Ambient Sensor(15K)	1	39000186
42	Temperature Sensor (20K)	1	390002004
43	Temperature Sensor (50K)	1	390002002
44	4-way Valve Coil	1	430004002
45	Electronic Expansile Valve Coil	1	43008765
46	Electric Box Cover2	1	1425212
47	Terminal Board	1	42011242
48	Wire Clamp	2	71010102
49	Isolation Washer D	1	70410525
50	Electric Box Assay2	1	1395355
51	Filter plate FS23588-40-24	1	43130019
52	Electric Box Cover Assay	1	1395356
53	Main PCB WZ863	1	30228604